

USER GUIDE

Single and Double Tap Tower Kits



U-LINE

RIGHT PRODUCT. RIGHT PLACE. RIGHT TEMPERATURE. SINCE 1962.

WELCOME TO U-LINE

Congratulations on your U-Line purchase. Your product comes from a company with over five decades of premium modular ice making, refrigeration, and wine preservation. U-Line continues to be the American leader, delivering versatility and flexibility for multiple applications including residential, light commercial, outdoor and marine use. U-Line's complete product collection includes Wine Captain Models, Beverage Centers, Clear ice Machines, Crescent Ice Makers, Glass and Solid Door Refrigerators, Drawer Models, Freezers, Combo Models, and more.

U-Line has captivated those with an appreciation for the finer things with exceptional functionality, style, inspired innovations and attention to even the smallest details. We are known and respected for our unwavering dedication to product design, quality and selection. U-Line is headquartered in Milwaukee, Wisconsin and has shipped product to five continents for over two decades and is proud to have the opportunity to ship to you.

PRODUCT INFORMATION

Looking for additional information on your product? User Guides, Spec Sheets, CAD Drawings, Compliance Documentation, and Product Warranty information are all available for reference and download at u-line.com.

PROPERTY DAMAGE / INJURY CONCERNS

In the unlikely event property damage or personal injury is suspected related to a U-Line product, please take the following steps:

1. U-Line Customer Care must be contacted immediately at +1.800.779.2547.
2. Service or repairs performed on the unit without prior written approval from U-Line is not permitted. If the unit has been altered or repaired in the field without prior written approval from U-Line, claims will not be eligible.

GENERAL INQUIRIES

U-Line Corporation
8900 N. 55th Street
Milwaukee, Wisconsin 53223 USA
Monday - Friday 8:00 am to 4:30 pm CST
T: +1.414.354.0300
F: +1.414.354.7905
Email: sales@u-line.com
u-line.com

SERVICE & PARTS ASSISTANCE

Monday - Friday 8:00 am to 4:30 pm CST
T: +1.800.779.2547
F: +1.414.354.5696
Service Email: onlineservice@u-line.com
Parts Email: onlineparts@u-line.com

CONNECT WITH US



Table of Contents

- Introduction 1
- Safety and Warning 1
- Parts Lists 2
- Tower Installation 3
 - Install on Refrigerator 3
 - Install on Countertop 4
- Connections 5
 - CO₂ Line 5
 - Beverage Line 6
- Set CO₂ Pressure 7
- Beverage Line Cleaning 8
- Potential Draft Issues 10
- Warranty 11
- Countertop Installation Template 12



Introduction

U-Line Single and Double Tap Kits are designed to work with the U-Line keg refrigerator model 1224KEGRSOD. Tap kits can be installed directly on top of the keg refrigerator in a free-standing application or through a countertop in a built-in application. The 1224KEGRSOD is designed to fit up to one $\frac{1}{4}$ slim barrel and one $\frac{1}{6}$ barrel or one standard $\frac{1}{4}$ barrel. It does not accept a $\frac{1}{2}$ barrel or larger keg.



$\frac{1}{4}$ Slim Barrel

Quarter Slim
7.75 Gallons
82 - 12 oz. cups
11.2" x 23.5"



$\frac{1}{6}$ Slim Barrel

Sixth Slim
5 Gallons
53 - 12 oz. cups
9.25" x 23.5"



Standard $\frac{1}{4}$ Barrel

Pony Keg
7.75 Gallons
82 - 12 oz. cups
11.2" x 23.5"

Safety and Warning

WARNING

CO₂ can be dangerous. Handle with care.

Never exceed 60 PSI.

Most draft beers are dispensed between 8-14 PSI and most stouts are dispensed at 30-14 PSI. Pressures above 50 PSI will release the built-in pressure relief.

Always connect CO₂ tank to regulator. Never connect the tank directly to the keg.

Ventilate area after CO₂ leak:

If it becomes difficult to breathe and your head starts to ache, high levels of CO₂ may be present.

LEAVE THE ROOM IMMEDIATELY.

Safety and Warning

CAUTION

Keep CO₂ tank in an upright position. The regulator may break if the tank falls.

Secure the CO₂ tank.

Kits include:

1. Single or Double Tower (includes faucet, handle, gasket, wrench, & clamp)
2. Low profile keg coupler (D system for North American Beers)
3. Regulator / CO₂ gauge (includes hose and clamps)
4. 5 lb. CO₂ cylinder (ships empty)
5. Drip tray
6. Cleaning kit (includes cleaning pump, detergent, faucet brush, washers)
7. Hardware for freestanding and built-in applications



Single-Faucet Tap
U-SINGLETAP



Double-Faucet Tap
U-DOUBLETAP

Install Tower on Keg Refrigerator

If your keg refrigerator is new out of the box, do not remove the protective film on the stainless exterior until the tower is installed.

Note: These instructions are designed for a standard 36" countertop application.

1. Remove four screws and lift off cap plug and gasket to reveal mounting hole on top of refrigerator.

Note: Save gasket and cap plug for conversion back to a standard refrigerator.

2. Insert tap assembly tubing through the provided gasket and then all the way into the refrigerator.
3. Insert and tighten four screws to secure tower to keg refrigerator.
4. Install faucet onto the tower: Line up teeth on the outside of the faucet with the teeth inside the shank.
5. Screw the coupling nut onto the faucet and tighten with the faucet wrench.
6. Screw the handle onto the faucet.

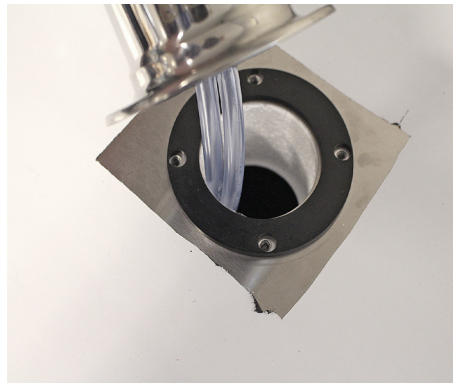
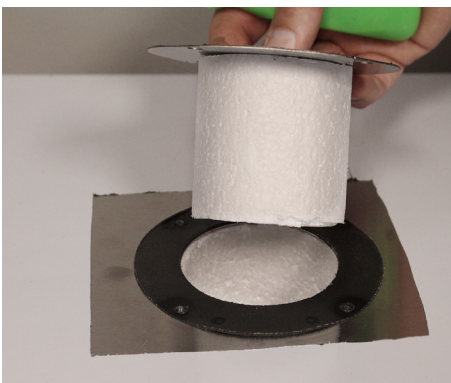

Install Tower on Countertop (see template at the end of this user guide)

1. Position keg refrigerator under countertop to determine the desired depth.
2. Use the dimensions from Diagram A to determine the centerpoint of the tower mounting hole.
3. Remove keg refrigerator from under countertop.
4. Use template to drill four mounting holes.
5. Drill 2-3/4" diameter hole through countertop.
6. Insert tubing through provided gasket and into 2-3/4" hole.
7. Secure tower to countertop.

Note: Screws included with the kit will accommodate many different countertops. For a customized fit, it may be necessary to acquire screws that are sized to the thickness of your countertop.

8. Position keg refrigerator in front of opening and feed tubing into the uncapped opening.
9. Slide keg refrigerator into place.
10. Remove cap from top of tower and push insulation down into the keg refrigerator - see Diagram B.
11. Continue with CO₂ and beverage connections - see pages 5-6.

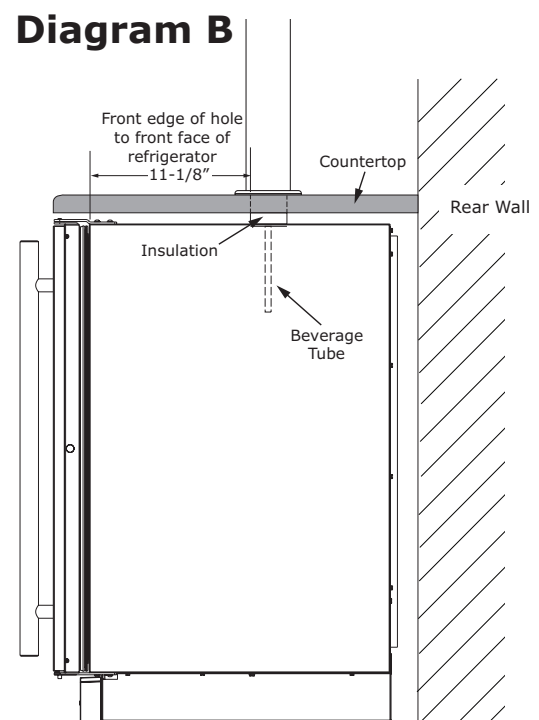
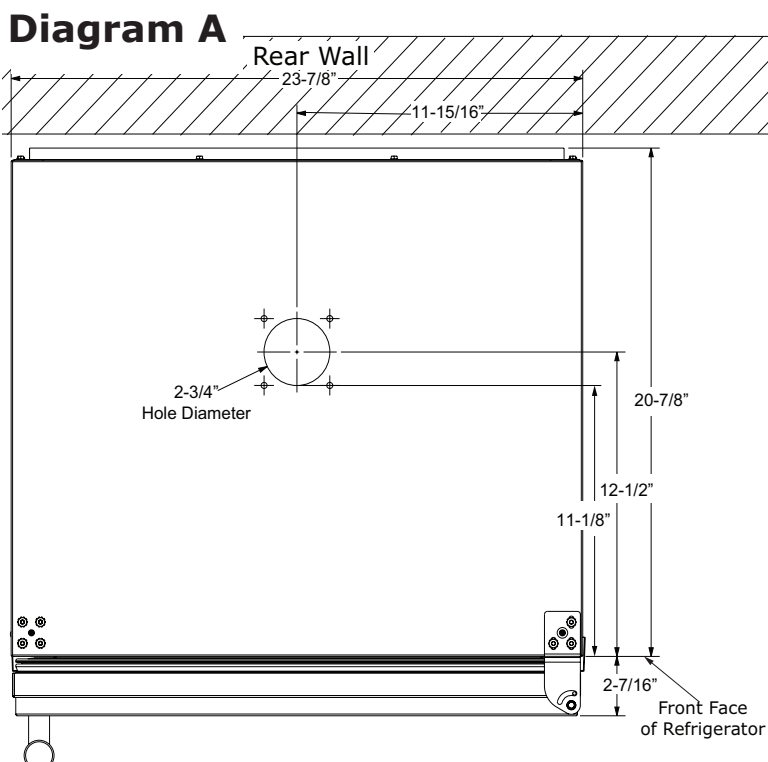
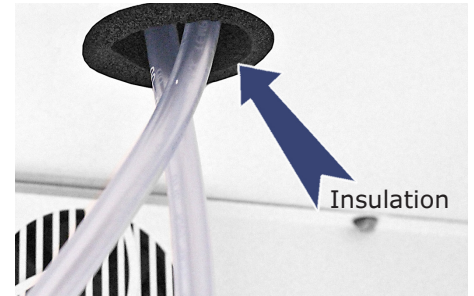
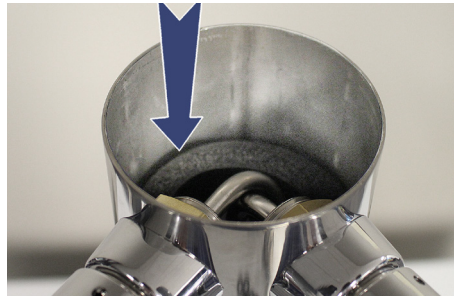

CO₂ Connection

Our CO₂ tanks are delivered empty and need to be filled locally. Check online for beverage or home brew supply stores in your area to have your tank filled.

1. Attach regulator to CO₂ tank. Hand tighten the coupling nut and then use an adjustable wrench for an additional quarter turn. **DO NOT OVER TIGHTEN**
2. Attach 5/16" CO₂ tubing to regulator nipple and clamp into place. If necessary, make the tubing more pliable by heating the end in boiling water.
3. Attach and clamp CO₂ tubing to tap coupler.



Beverage Connection

1. Attach and clamp beverage tubing to tap coupler.
2. Attach tap coupler to keg. Locate notch and rotate clockwise $\frac{1}{4}$ turn.
3. Press down and rotate clockwise an additional $\frac{1}{4}$ turn.
4. Open valve on CO₂ tank and adjust regulator to desired pressure by turning the handle clockwise.



Setting CO₂ Pressure

To minimize foam for most beverages the pressure should be set between 8-12 PSI.

- Set the pressure by turning the handle on the front of the regulator counterclockwise until it is all the way out. This will turn the regulator off.
- Turn the valve on the bottom of the regulator to the side to ensure no CO₂ will pass through the regulator.
- Pull the pin on the side of the coupler to release built up pressure from the keg. Open the faucet. Nothing should come out initially as there is no pressure to the keg.
- Place a container under the faucet and open the valve on the bottom of the regulator.
- Turn the handle clockwise with the faucet open and your beverage will start to pour. Stop turning when you get the best flow rate. This method should prevent your regulator from creeping.

If you are dispensing at altitude, you will need to increase your output pressure by one pound for every 2,000 feet of elevation above sea level.



1. Close CO₂ tank.
2. Pull pin on coupler to release pressure from keg.
3. Remove tap coupler from keg.
4. Remove CO₂ line from tap coupler.
5. Open tap coupler to allow cleaning solution to flow through it:
 - Push base of coupler inward and rotate clockwise.
6. Open cleaning pump.
7. Empty one packet of cleaner into plastic jar and fill with cool water.
8. Reassemble pump.

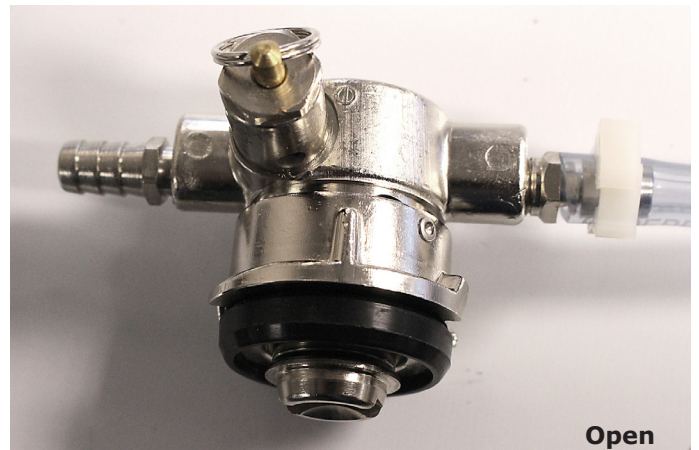
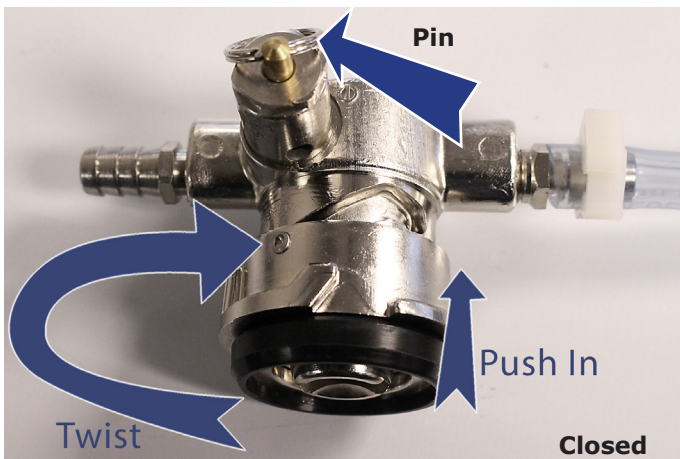

**Continued on
next page**

9. Remove faucet from tower with supplied faucet wrench. Disassemble, and place all the parts in drainage bucket.
10. Add washer and attach cleaning pump connector to tower. Tighten with faucet wrench.
11. Pump all the solution through the beverage line.
12. Allow tap coupler and faucet to soak in drainage bucket and then use faucet brush to clean faucet.
13. Rinse out and refill plastic jar with clean water. Pump all the water through the beverage line to rinse.
14. Rinse all disassembled parts with clean water.
15. Reassemble faucet and reconnect CO₂ and beverage lines.

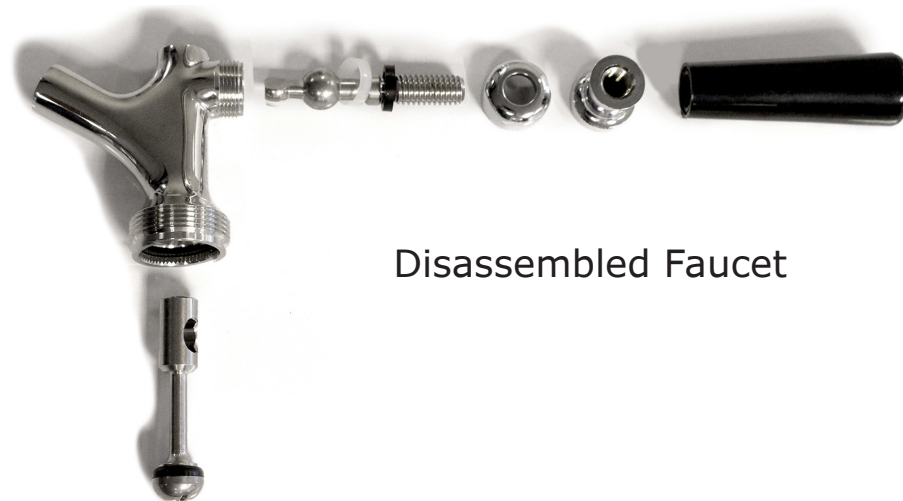
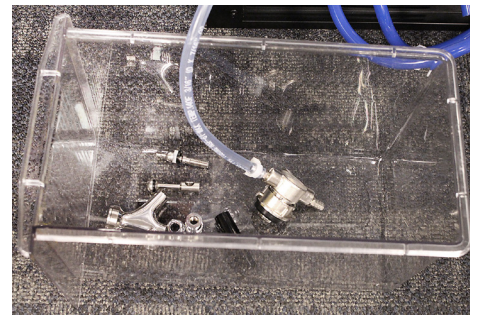

Disassembled Faucet

Potential Draft Issues

WILD BEER

Description:

Beer, when drawn, is all foam, or too much foam and not enough liquid beer.

Causes:

- Beer drawn improperly
- Creeping Regulator
- Applied pressure is set too high
- Hot spots in the line
- Use of non-insulated beer line
- Beer runs are too long for proper cooling
- Tapped into a warm keg (Should be 34° - 38°)
- Cooler malfunctioning
- Kinks, dents, twists or other obstructions in line
- Faucets in bad, dirty, or worn condition

FLAT BEER

Description:

Foamy head disappears quickly; beer lacks usual zestful brewery-fresh flavor

Causes:

- Dirty glasses
- Sluggish regulator
- Applied pressure is set too low
- CO₂ is turned off at night
- Contaminated air source (associated with compressed air)
- Moisture in air system
- Beer is too cold
- Loose tap or vent connections

CLOUDY BEER

Description:

When beer in glass appears hazy, not clear

Causes:

- Frozen or nearly frozen beer
- Old beer
- Beer that has been unrefrigerated for long periods of time
- Dirty glass
- Dirty faucet
- Unrefrigerated foods placed on top of cold keg
- Contaminated air source

FALSE HEAD

Description:

Large soap-like bubbles, head dissolves very quickly

Causes:

- Applied pressure required does not correspond to beer temperature
- Small beer line into a large faucet shank
- Beer lines warmer than beer in keg
- Dry glasses
- Improper pour

UNPALATABLE BEER

Description:

Off-Taste

- Contaminated air source, or unfiltered
- Unsanitary bar conditions

Sticky Faucet

A sticky/sticking faucet is usually attributed to the beer drying up at the point of the seal of the faucet valve. Inside the faucet is a neoprene gasket that presses against the metal inside of the faucet, creating the seal to close the faucet. When you close the faucet, the residual beer caught between the seal can dry up over time.

Solutions:

- Clean faucet, lines, and coupler as described earlier
- Wrap faucet body with a hot washcloth for several minutes

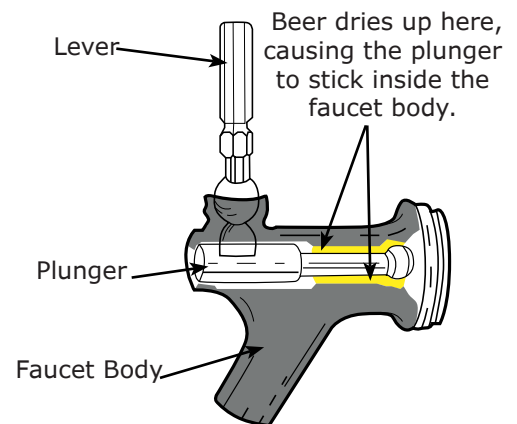

Warranty / Support

U-Line will replace missing or defective components for 60 days from date of purchase. Contact U-Line at +1.800.798.2547. Proof of purchase is required.

Additional tap accessories and cleaning solution are available at your local brewing supply store or online.

Template for Countertop Installation

Note: Verify template has printed true to scale - double check hole dimensions and placement.

